

General

VTP centrifugal pumps in block design (BBF) correspond to the system of two-pipe pumps.

Basically these immersion pumps are single-level immersion pumps with vertical axis the main components of which are combined according to the proven module system.

The drive motor is located in the dry section above the fastening plate. The pump head is immersed in the medium.

VTP-BBF immersion pumps are designed without bearings and are suited to convey low-viscosity, aggressive acidic, alkaline and solutions from **depressurized** tanks.

The efficient immersion depth can be increased by max. 300 mm by using a suction pipe. Furthermore the pump head can be equipped with a coarse at the suction connector.

Constructional features

VTP-BBF immersion pumps are characterized by their simple and sturdy design. The immersion pipe is fitted with a rigid supporting plate and thick sides. The sealing between spiral casing and immersion pipe is realized by a labyrinth seal.

The hydraulic parts such as spiral casing, impeller, etc. are standard components from the standard pump program.

The drive motor (basic version according to IEC) is equipped with an extended shaft. Therefore it is not necessary to provide the shaft with a bearing in the pump head area so that dry running is prevented and operation is almost maintenance-free.

Applications

There is a variety of possibilities to use vertical immersion pipes. They are generally suitable for applications which do not allow to convey the media from depressurized tanks, basins and reservoirs with dry pumps due to the local constructional, physical or safety requirements. The maximum operating temperature depends on the concentration of the medium, a temperature of 80° C must, however, not be exceeded for the material PP.

Materials

All parts in contact with the medium are made of PP, elastomers are of EPDM or FPM.

Shaft

The drive shaft of high-quality steel is coated with a PP shaft protection pipe in the area of the medium.

Impeller

The impeller form is radial.

The individual sizes are supplied with the following impellers: sizes 15-85, 20-120 and 25-135 in open form, all other sizes in closed form (open impellers on request).



Inlet and outlet pipe connection

The suction opening is located in the lower section of the pump, i.e.: the medium enters the pump body axially. The outlet pipe connection is situated in the dry section above the tank cover.

Drive

Surface-cooled three-phase motors according to IEC standard, 2900 rpm, protection class IP55, insulation class F, mounting IM V1. The motor has an extended shaft.

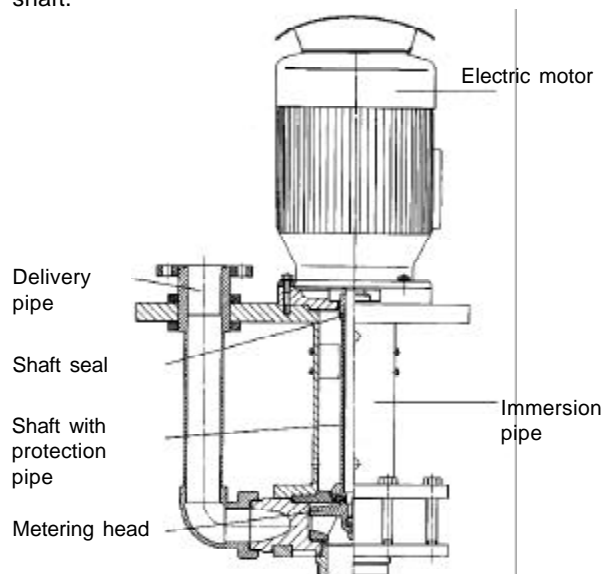

Type VTP 15 - 85 BBF

Motor kW: 0.37
Speed: 2880

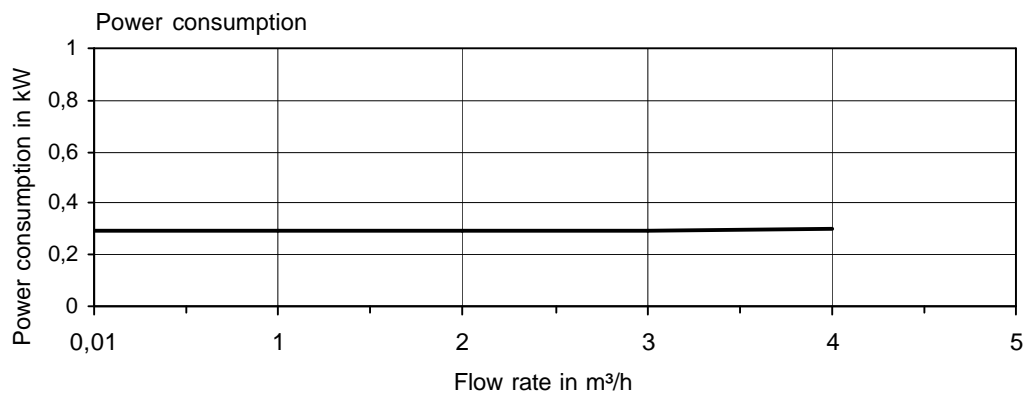
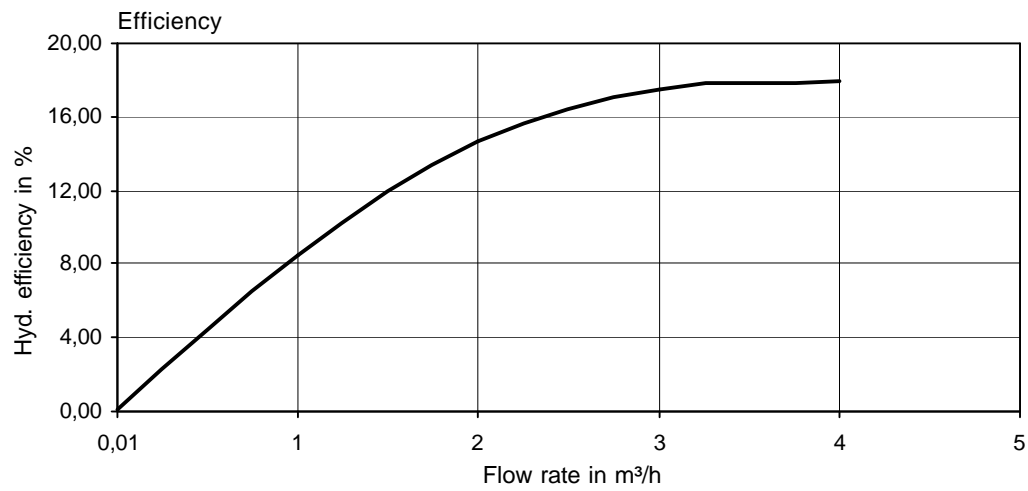
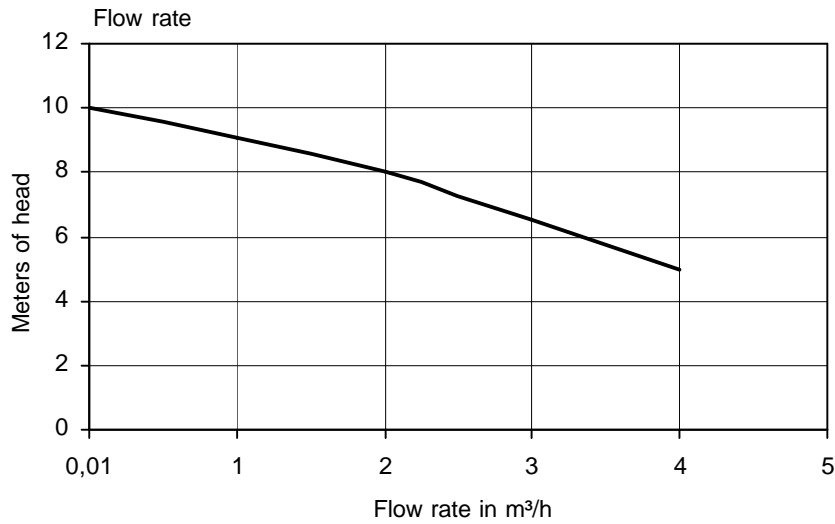

Typ VTP 20 - 120 BBF

Motor kW: 1.1
Speed: 2850

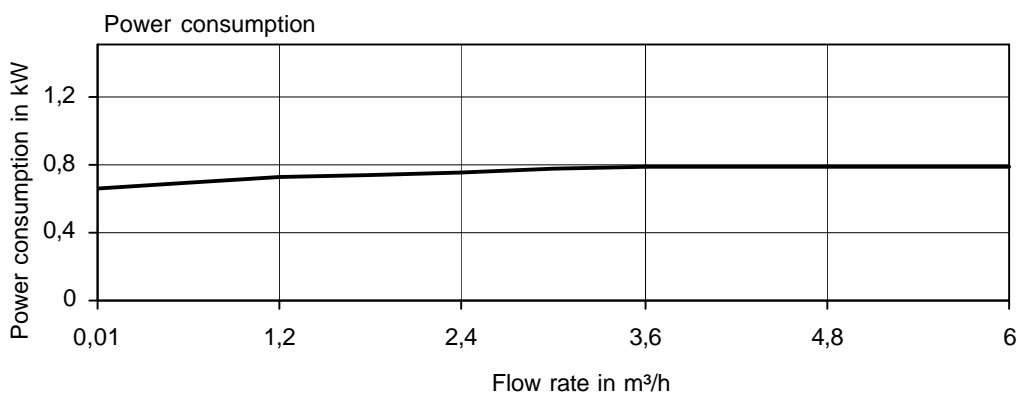
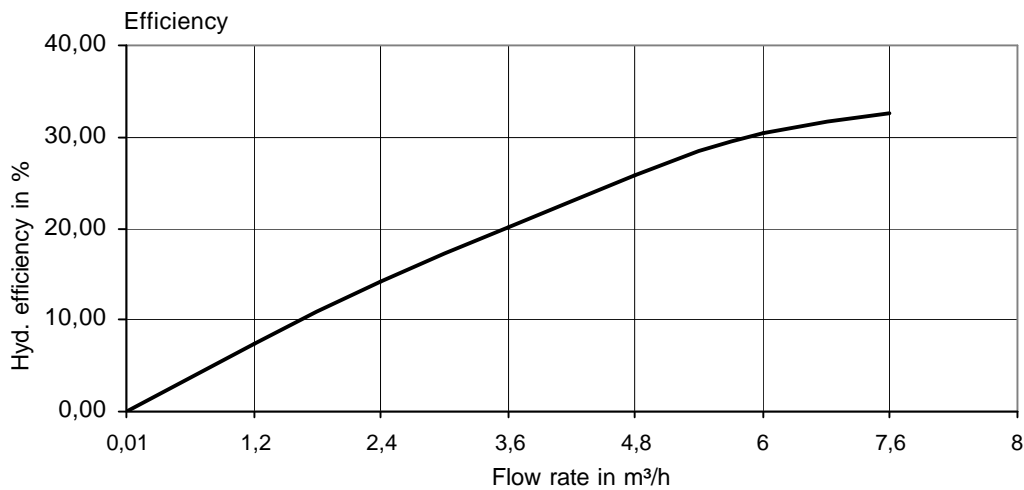
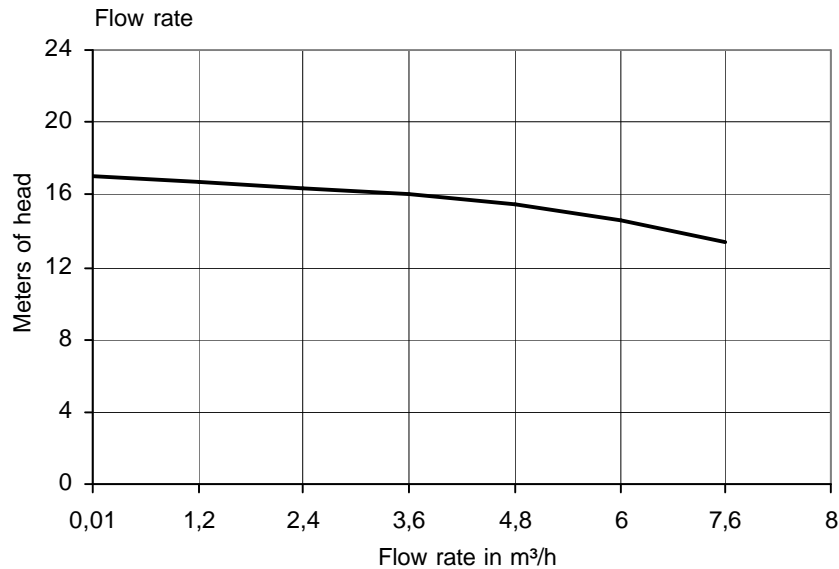

Type VTP 25 - 135 BBF

Motor kW: 1.5
Speed: 2860

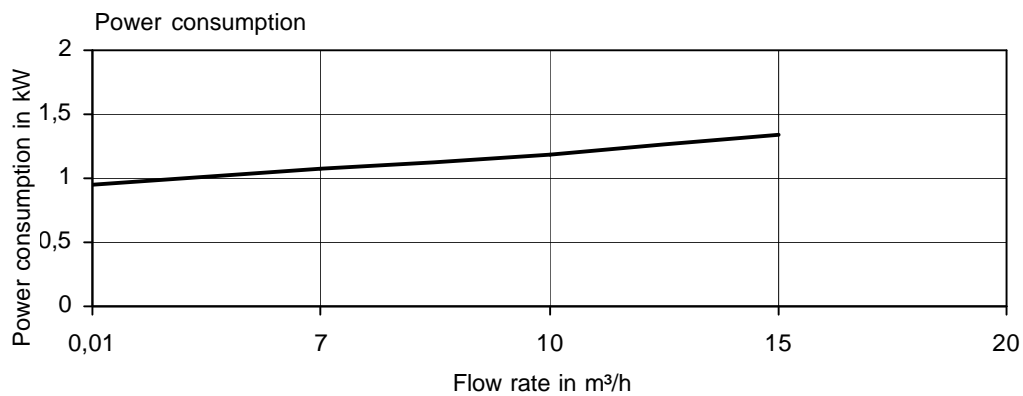
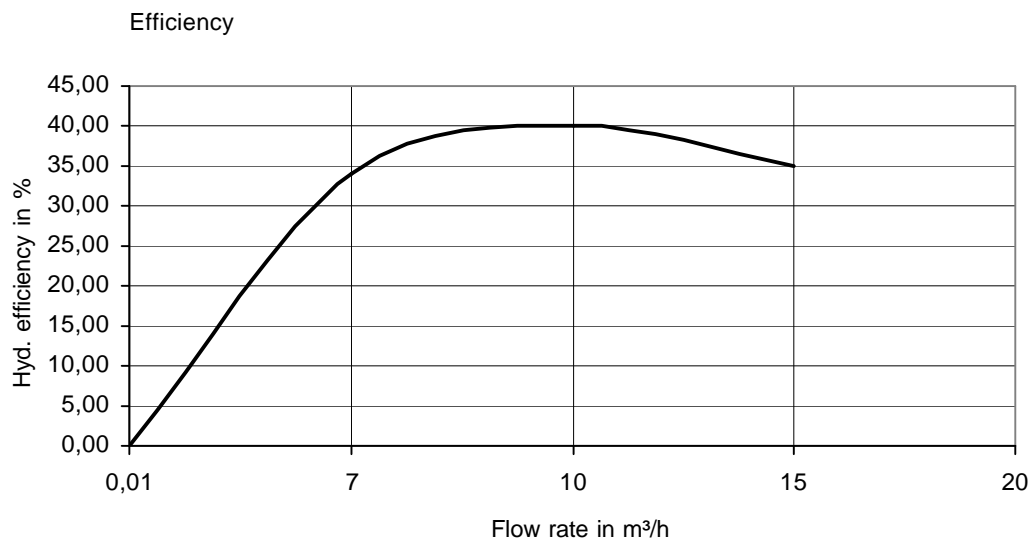
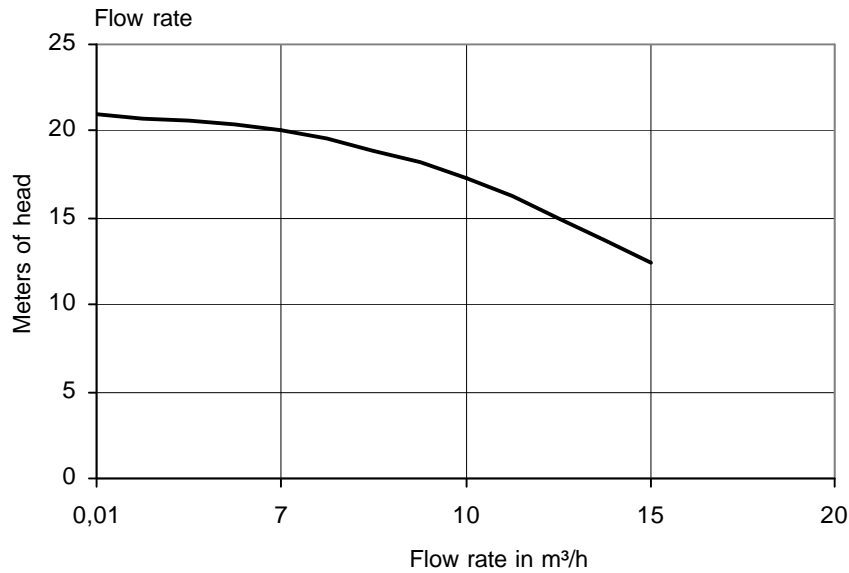

Type VTP 32 - 125 BBF

Motor kW: 1.5
Speed: 2850

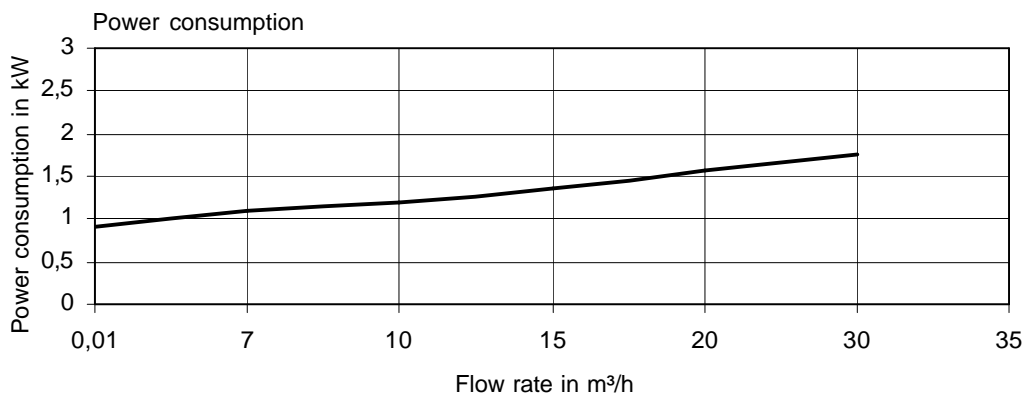
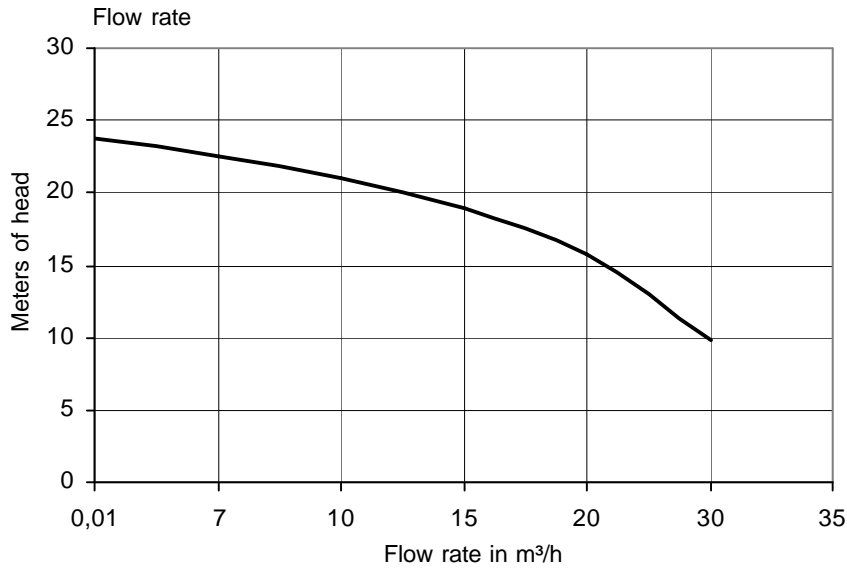

Type VTP 32 - 160 BBF

Motor kW: 3
Speed: 2880

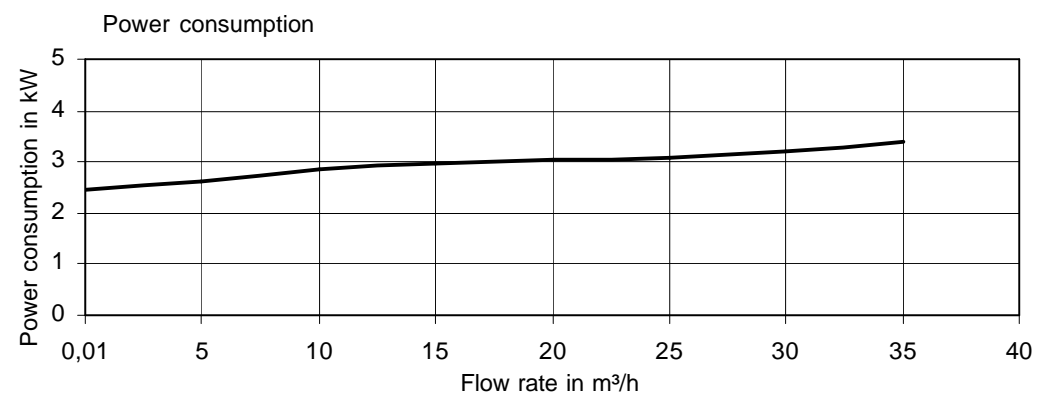
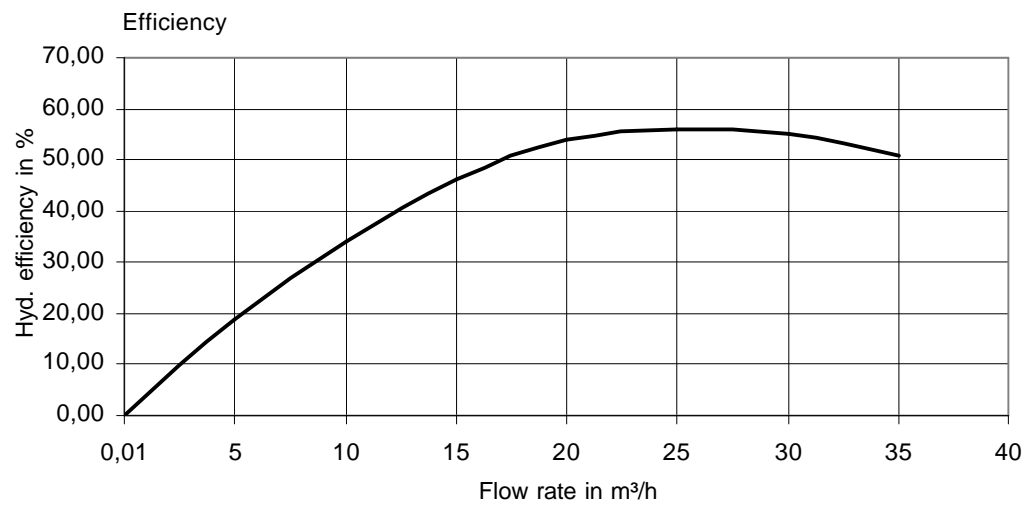
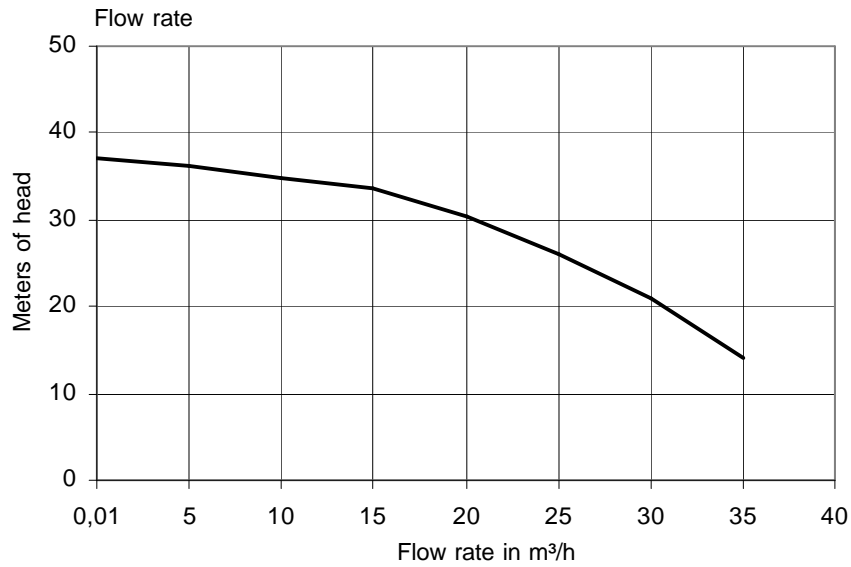

Vertical Immersion Pump VTP - BBF

Type VTP 40 - 125 BBF

Motor kW: 3
Speed: 2880

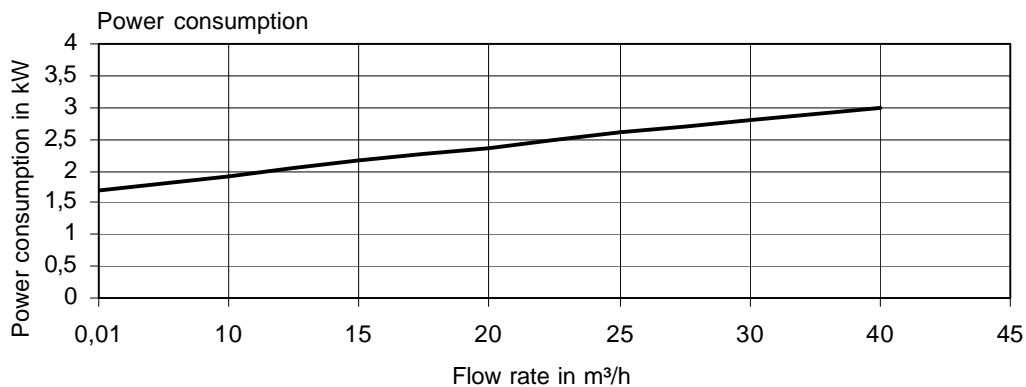
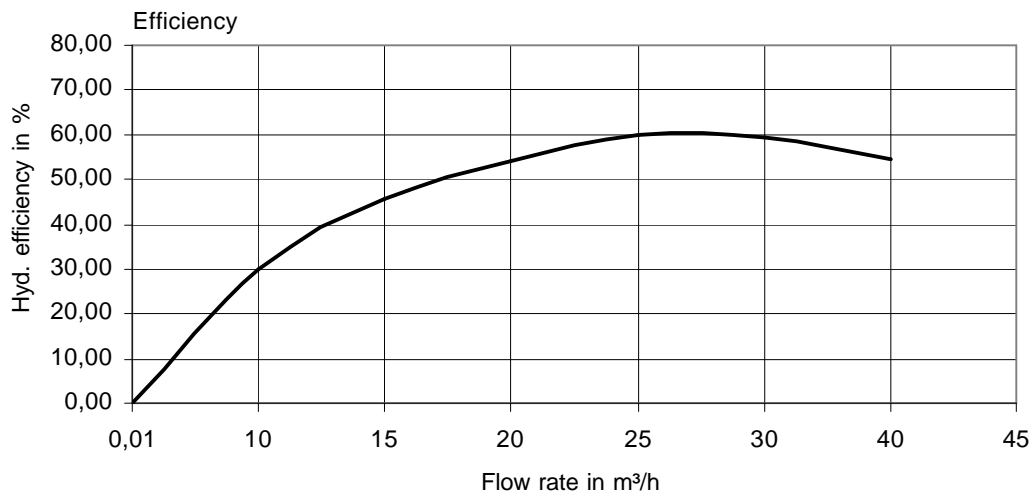
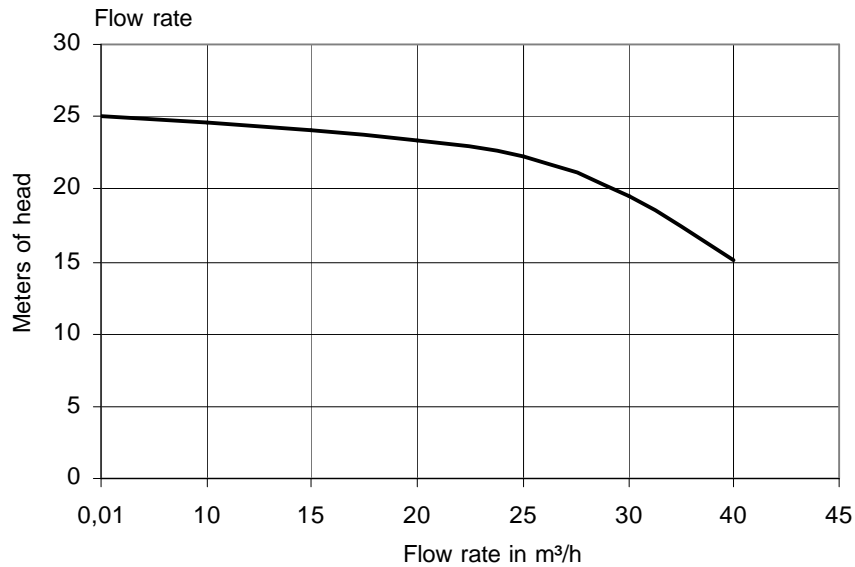

Type VTP 40 - 160 BBF

Motor kW: 4
Speed: 2900

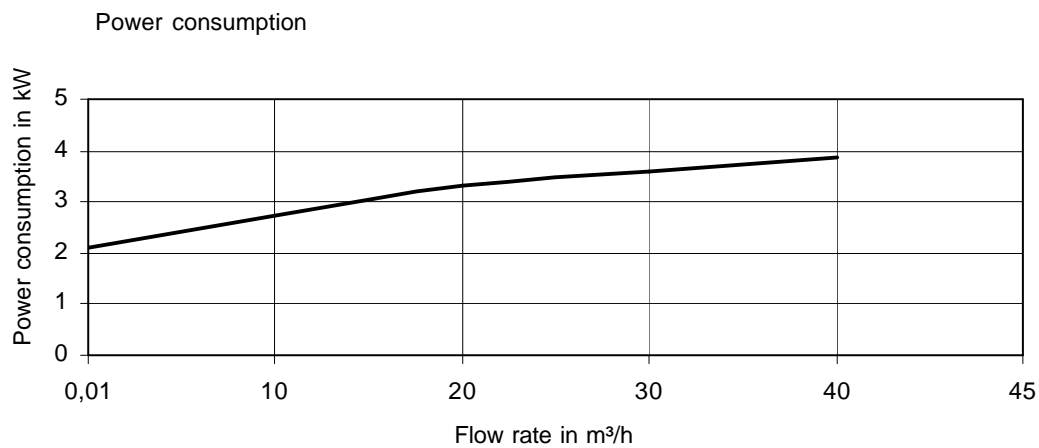
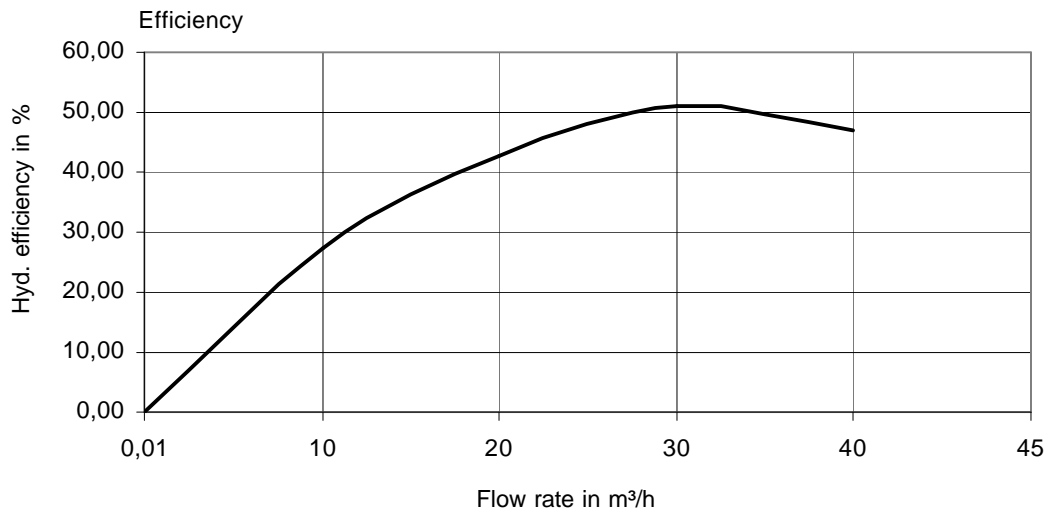
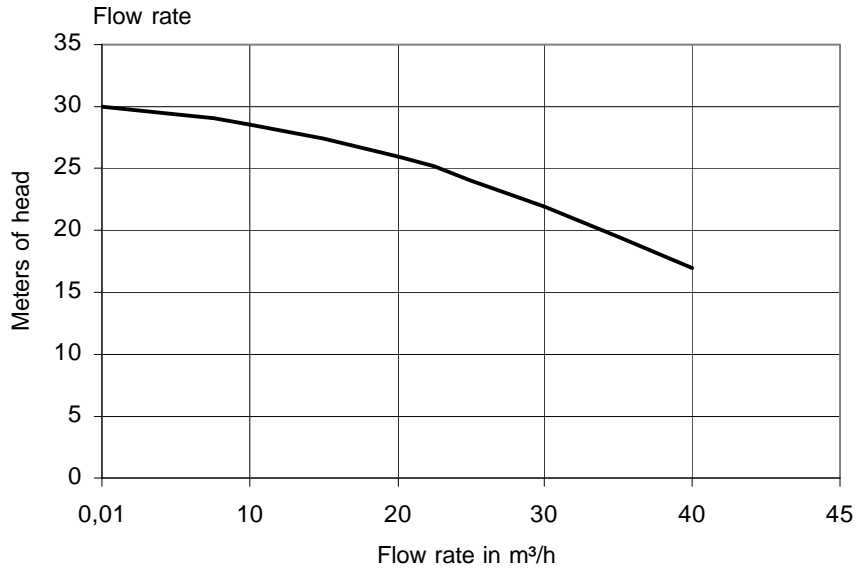

Type VTP 50 - 125 BBF

Motor kW: 5.5
Speed: 2915

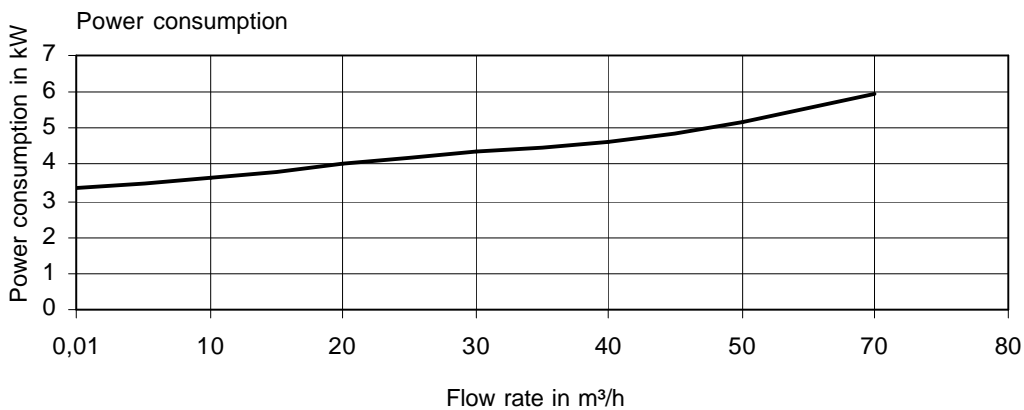
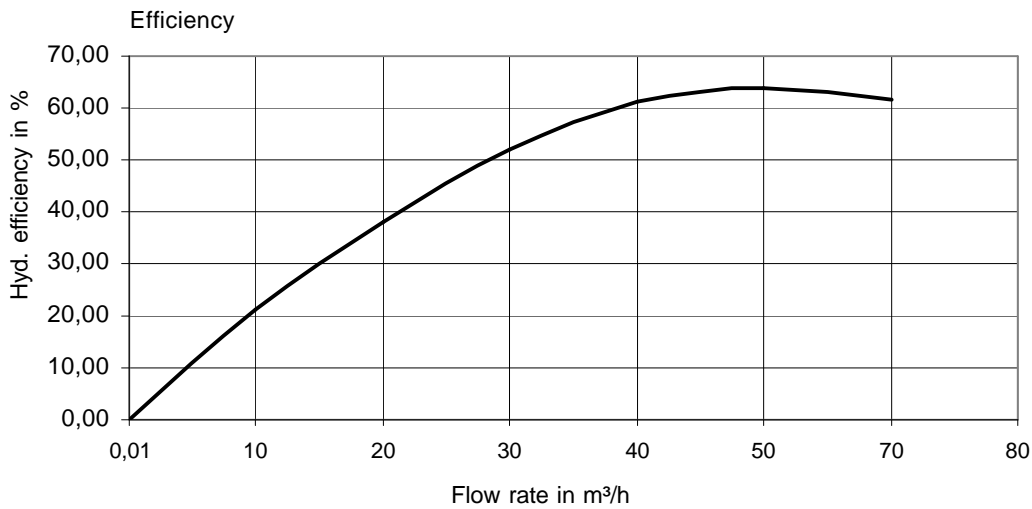
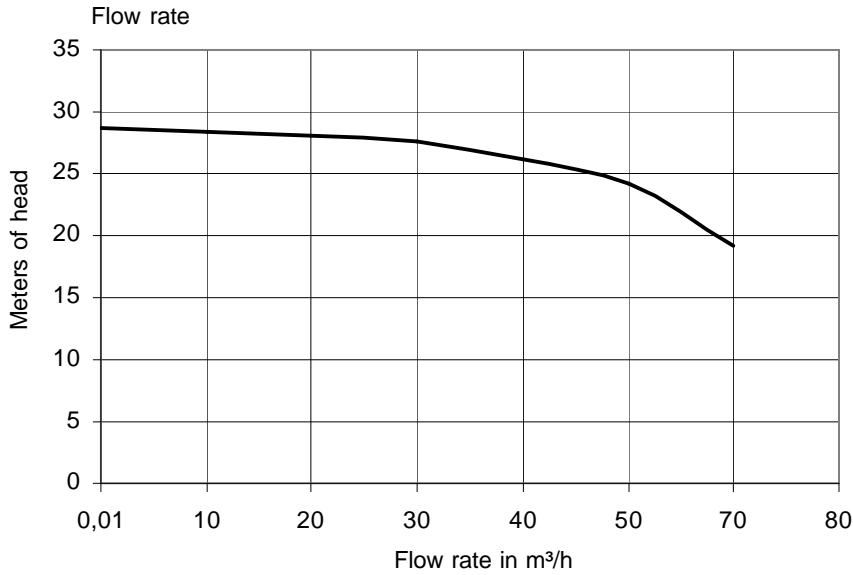

Type VTP 50 - 160 BBF

Motor kW: 11
Speed: 2900

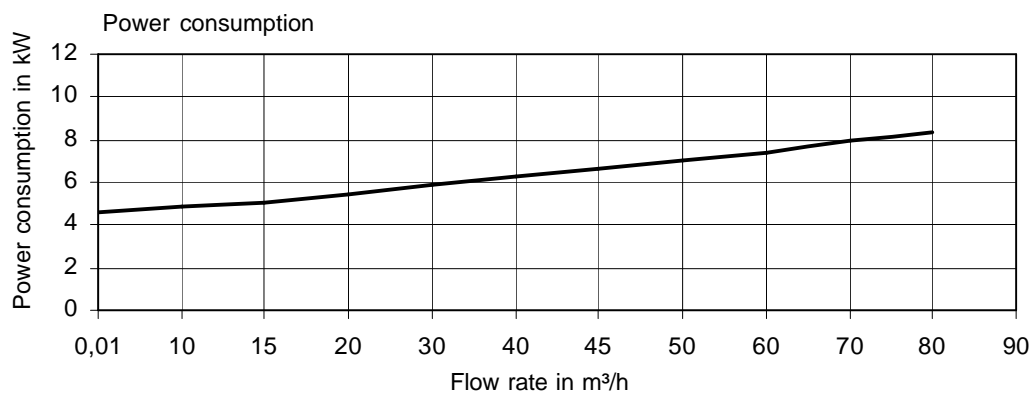
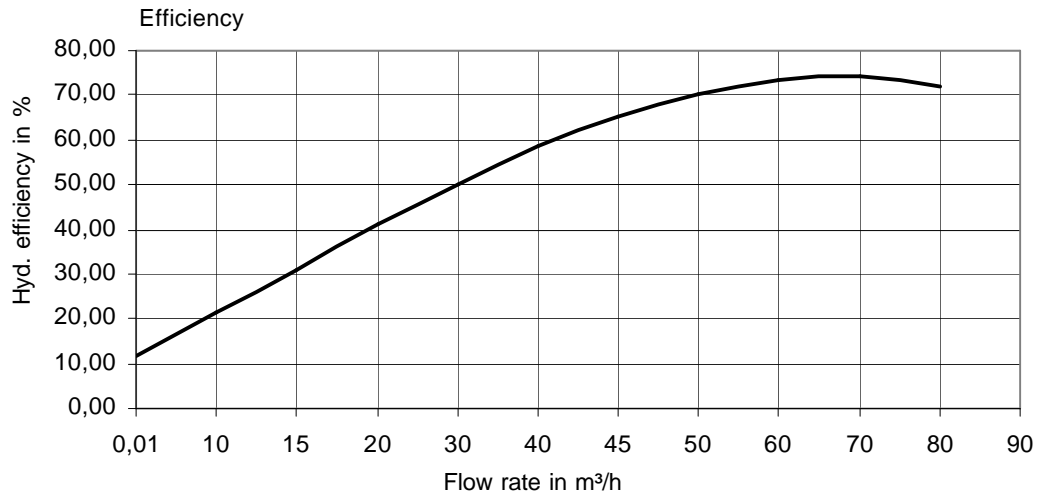
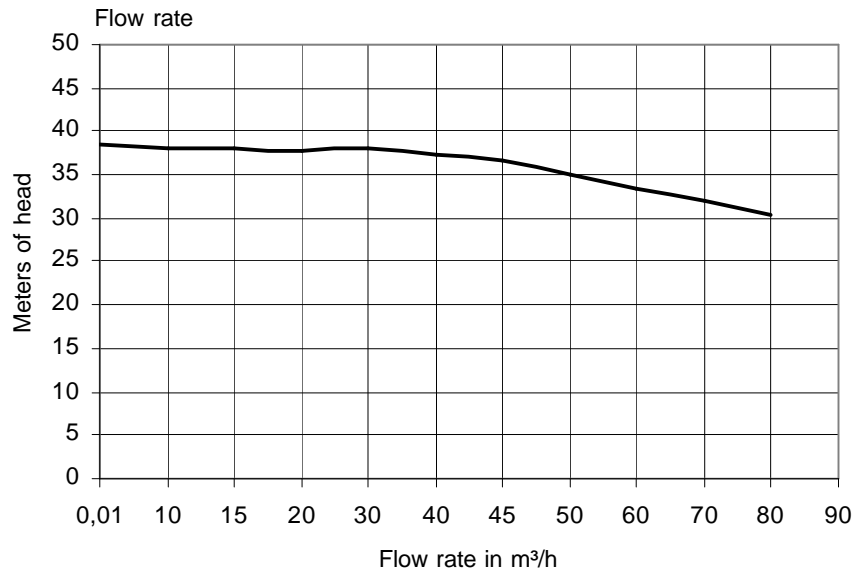

Type VTP 65 - 125 BBF

Motor kW: 7.5
Speed: 2930

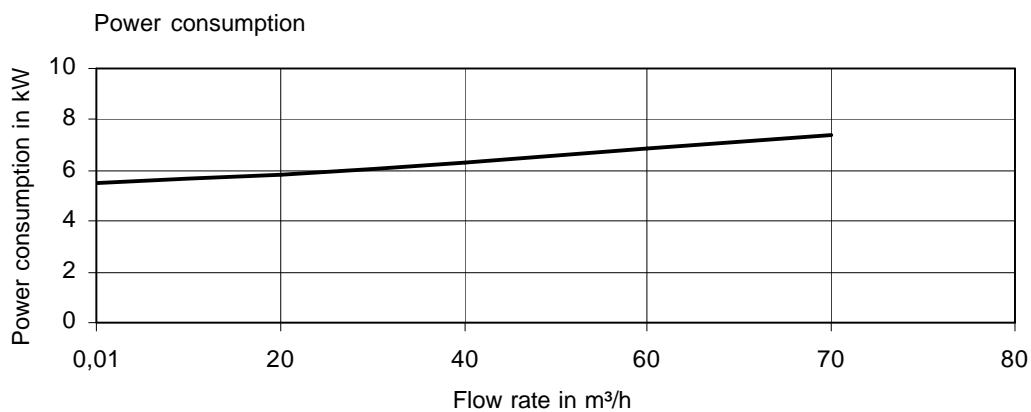
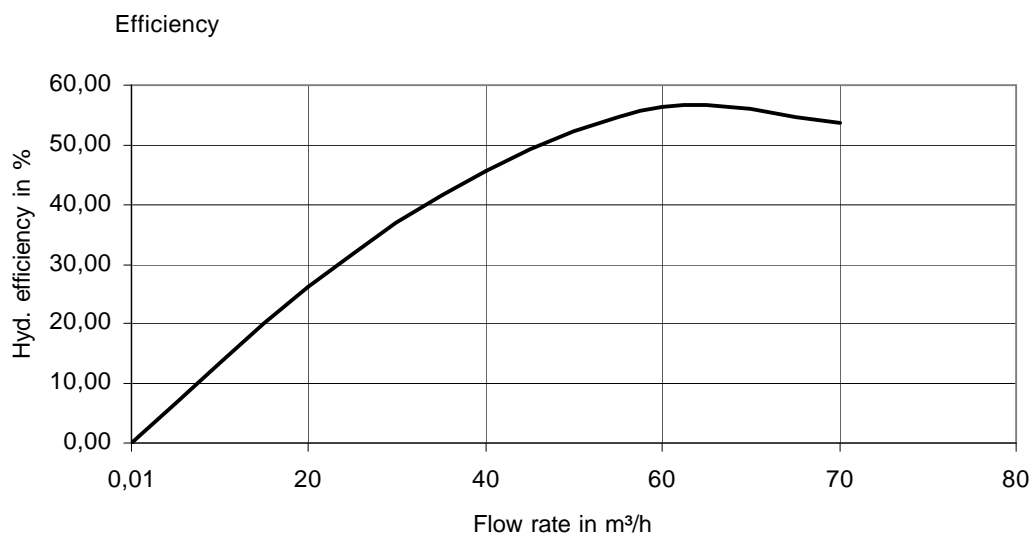
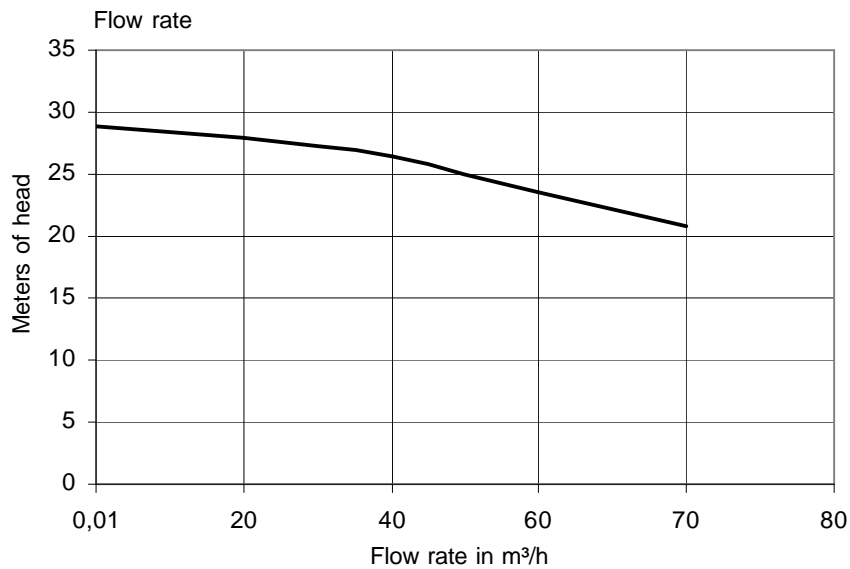

Type VTP 65 - 160 BBF

Motor kW: 3
Speed: 1450

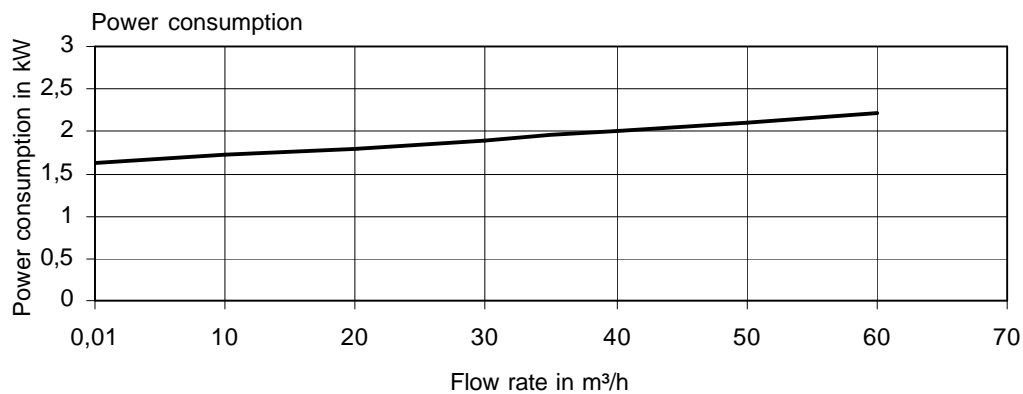
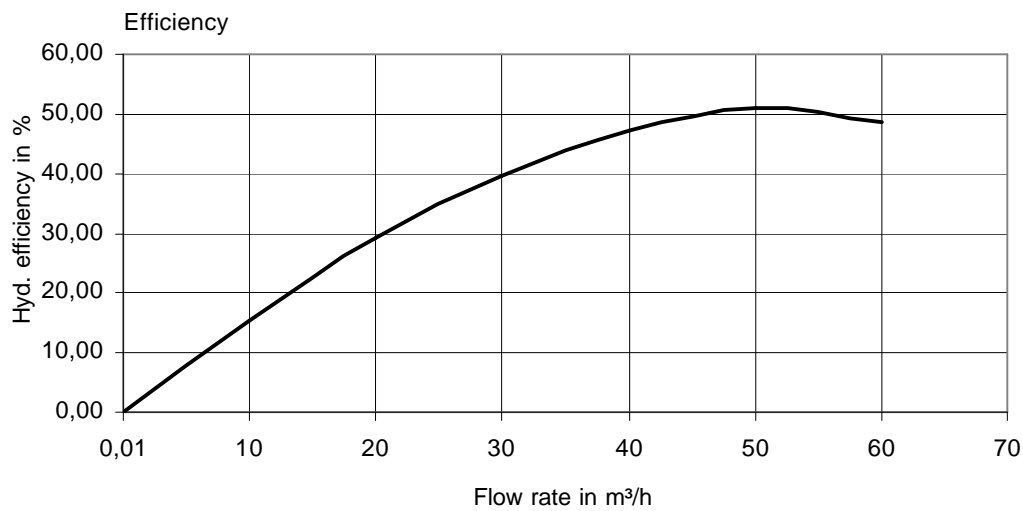
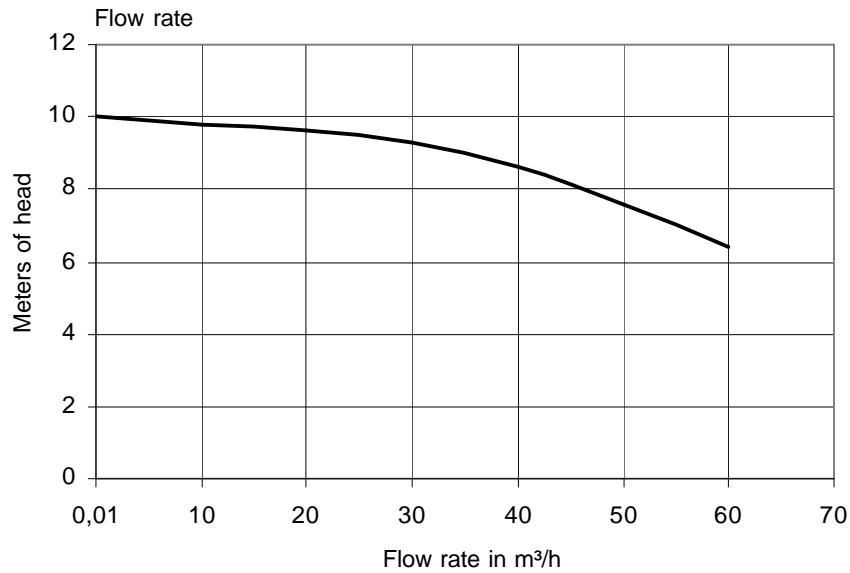

Type VTP 65 - 200 BBF

Motor kW: 7.5
Speed: 1750

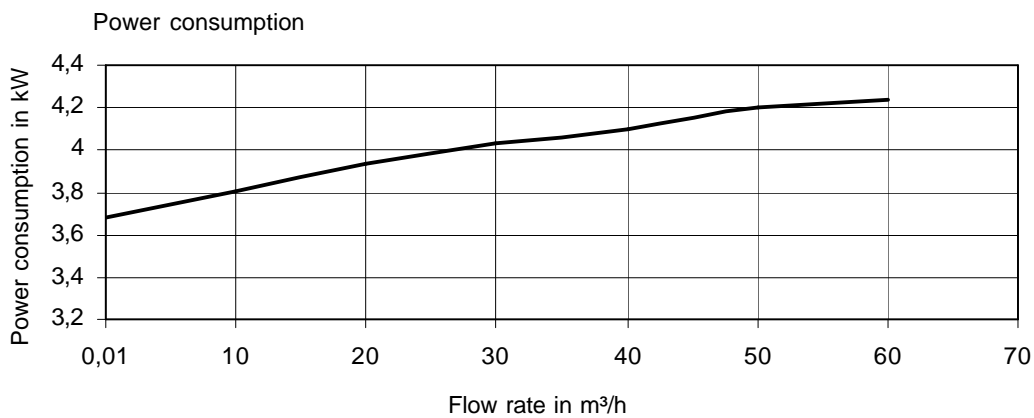
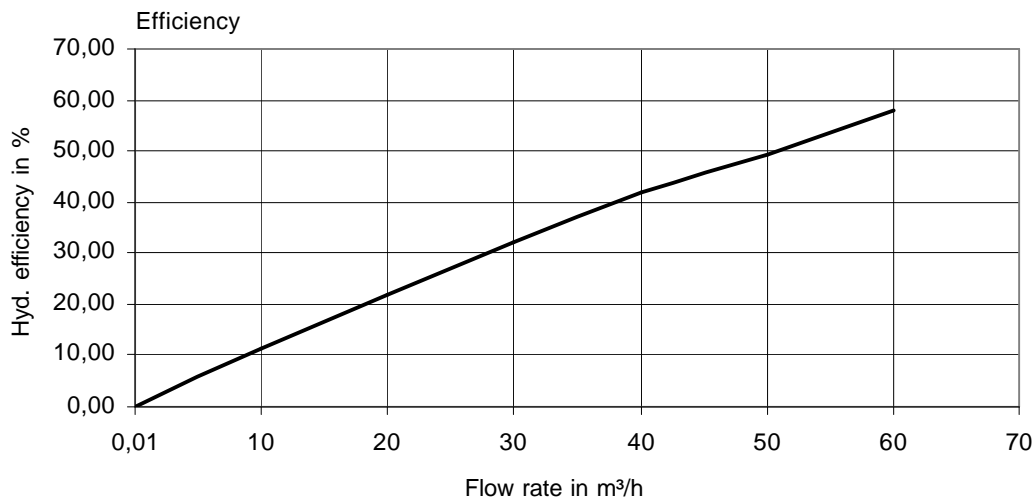
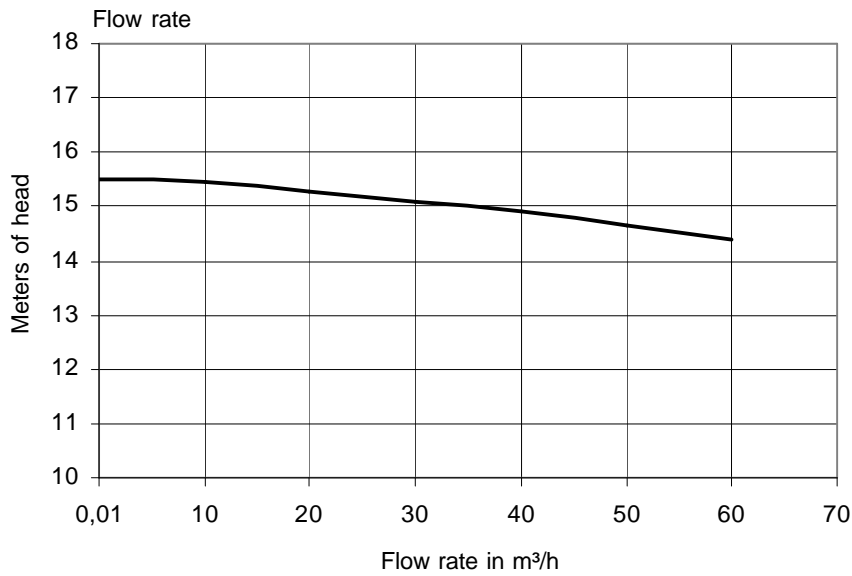

Dimensions of centrifugal pump

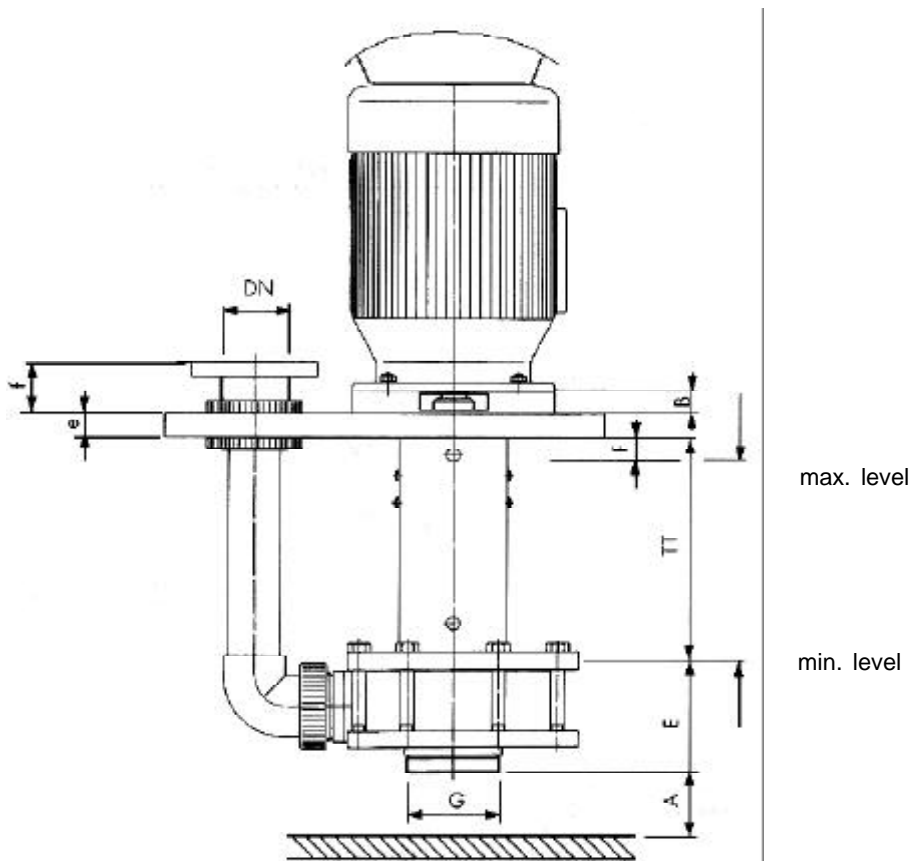

Type	DN	E + TT	A	B	E	F	G	e	f
15 - 85	15	300	20	60	90	30	G 1 1/4	25	50
20 - 120	20	300/400	25	90	122	30	G 2 1/4	25	50
25 - 135	25	300/400	32	90	122	30	G 2 1/4	25	50
32 - 125	32	Flange DIN 2501/PN10 Selectable immersion depth 300, 400, 500 mm	55	35	110	35	G 3	25	50
32 - 160	32		55	35	110	35	G 3	30	50
40 - 125	40		65	35	110	40	G 3 1/2	30	50
40 - 160	40		65	35	120	40	G 3 1/2	35	50
50 - 125	50		80	35	131	40	G 4	35	75
50 - 160	50		80	35	131	40	G 4	35	60
65 - 125	65		100	35	160	40	G 4 1/2	35	70
65 - 160	65		100	35	160	40	G5	35	70
65 - 200	65		100	35	144	40	G5	35	70

Immersion depth=E+TT

Dimensions of tank opening

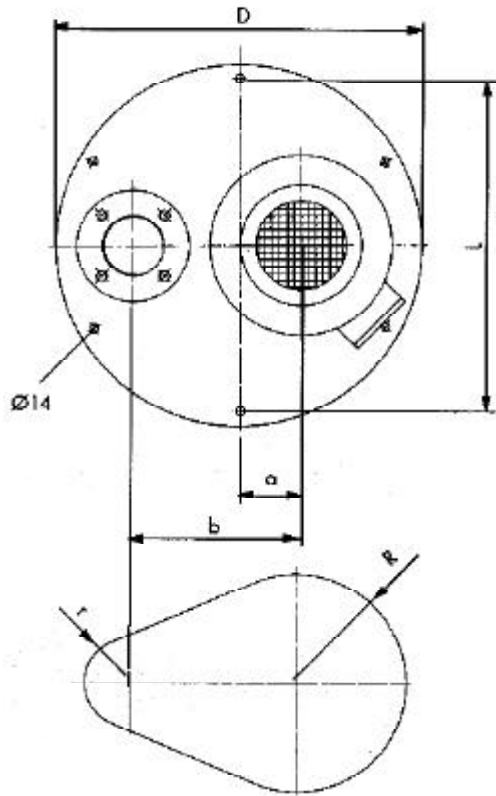

min. required
tank opening

Type	D	L	R	r	b	a
15 - 85	370	340	68	35	120	30
20 - 120	380	350	102	40	165	40
25 - 135	400	370	107	45	175	53
32 - 125	445	415	140	45	196	50
32 - 160	482	450	145	45	216	52
40 - 125	472	438	146	53	204	54
40 - 160	500	466	153	53	225	52
50 - 125	600	510	148	63	232	73
50 - 160	560	526	173	63	255	71
65 - 125	600	550	180	73	274	100
65 - 160	650	600	190	73	293.5	100
65 - 200	660	630	200	73	318.5	113